



## SIS2 INSTRUCTIONS QUICK GUIDE

### Switching On

Press and hold the  to switch to on at the medium Automatic setting.

or

Press and hold the  to switch on a last brightness setting used.

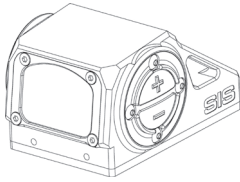





### Switching Off

A long press of both buttons together in auto or manual mode will switch the sight off. Your current setting will be saved and can be

**IMPORTANT!!**  
PLEASE ENSURE ALL FIREARMS ARE CLEAR AND  
SAFE BEFORE CONTINUING

### Changing the Reticle

Tap both the  and  buttons together to enter reticle change mode. The reticle will begin flashing to indicate that its in selection mode. You can now cycle between the reticle options by pressing the  or  buttons.

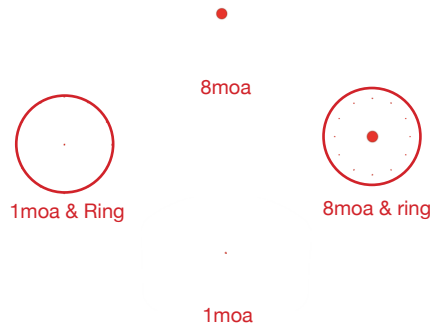

When you find the reticle you wish to choose. Tap both buttons together again, or wait 5 seconds for the reticle to stop flashing.

### Manual Brightness Adjustment

Press and hold  for 1 second to go into level 12 manual from auto

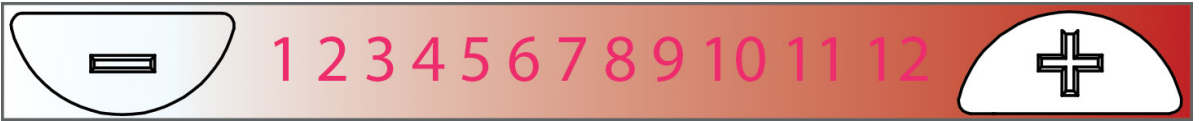

Press and hold  for 1 second to go into level 4 manual from auto  
Once in manual mode you can use + and - to adjust to your needs

**Elevation Adjustment:**  
Clockwise rotation = Group down

**Windage Adjustment:**  
Clockwise rotation = Group right

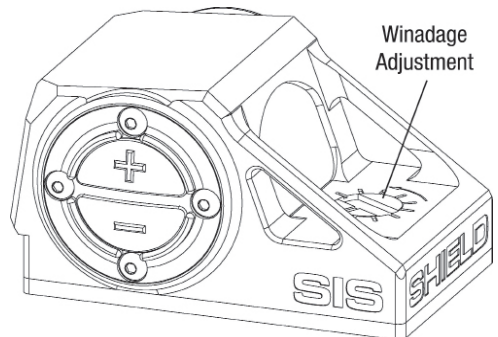
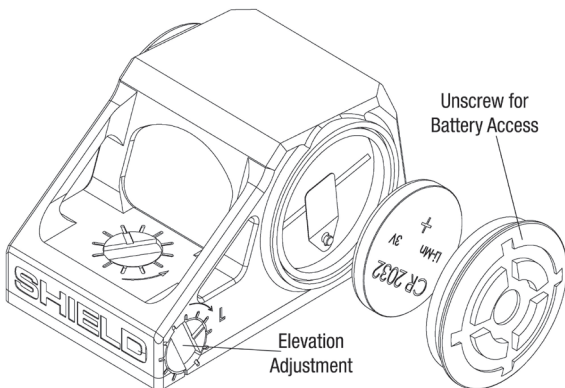

ENSURE THAT YOU KEEP TOOLS SAFE FOR FUTURE USE



## SIS2 INSTRUCTIONS

### Accessories: Included in pack

Shield SIS2 Sight  
2x Low Head M4x16mm screw  
2x Low Head M4x10mm screw  
Triple Height Polymer Sight Mount  
2x Low Head M4x22mm screw  
1 x 2.5mm AF Hex key  
Sight Cover  
1 x 2032 Battery

### General Care:

Decide what height you want to mount your SIS2 at and affix the associated spacer. Attached the mounting layer and bolt to the rail.

**Battery Fitting:** The SIS2 Sight uses a 3V Lithium battery type CR 2032 which under average use can last 1 to 2 years. Replacement is required when the intensity of the dot appears greatly diminished against a bright background.

### Warranty - Shield Products

Products designed and manufactured by Shield carry a Limited Lifetime warranty on materials and workmanship.

For more details on SHIELD's warranty please see our website [www.shieldsights.com/warranty](http://www.shieldsights.com/warranty)

### IMPORTANT NOTICE TO PURCHASER

The following is made in lieu of all warranties, expressed or implied, including the implied warranties of merchantability and fitness for purpose: Seller's and manufacturers only obligation shall be to replace such elements of the product proved to be defective. Before using, user shall determine the suitability of the product for its intended use, and user assumes all risk and liability whatsoever in connection there with.

NEITHER SELLER NOR MANUFACTURER SHALL BE LIABLE EITHER IN TORT OR IN CONTRACT FOR ANY LOSS OR DAMAGE, DIRECT, INCIDENTAL, OR CONSEQUENTIAL, ARISING OUT OF THE USE OR THE INABILITY TO USE THE PRODUCT.



For instructional videos on mounting, lens cleaning and changing the battery please visit our YouTube channel or our website.

[www.youtube.com/c/ShieldSights](http://www.youtube.com/c/ShieldSights)

**IMPORTANT!!**  
**PLEASE ENSURE ALL FIREARMS ARE CLEAR AND SAFE BEFORE CONTINUING**

### Adjustment and Zeroing

Always make sure that the gun is unloaded and the chamber is clear before any adjustments are made. Always be sure of your backstop.

THE DOT IS ALWAYS ADJUSTED TOWARDS THE POINT OF IMPACT

Adjustment can be made to the windage and elevation screw using a flat screwdriver. The SIS2 indicates turn clockwise for Left on the windage and Up on the Elevation, these are marked 'out of error'

Move dot right by clockwise rotation of the socket screw, move dot left by counter clockwise rotation of same screw. Move dot up by clockwise rotation of the top adjustment screw, move dot down by anti-clockwise rotation of same screw. DO NOT force adjustment, in either direction, once resistance is felt, as this will damage the body.

Remember - Always move dot towards the point of impact, so if a group shot is high and right of the centre of the target, then move the dot up and to the right to cover the position of the group.

### SIS2 Materials

Body: Aerospace grade hard anodised Aluminium

Lens: The clear, polymer optic has negligible loss of light transmission, great accuracy and can withstand up to 10 times greater shock impact than products with glass optics.

LED Insert: Consists of a microelectronic unit contained within a robust waterproof encapsulated insert. This is mounted with gold plated battery contacts extending out at either side. The LED insert senses target light levels and controls the light output of the LED to give optimum visibility of the dot against the target.

Accessories: Snap on Cover, which protects the optic and prolongs battery life in day light

Technical data: Weight with battery - 2.2oz (63.Sg) Size - 2inch (52mm) long, 1.25inch (31mm) wide and 1.2 inch (30mm High) Temperature range- 40 to +70 degrees centigrade. Battery type Lithium CR2032, dark storage battery life approx 3years

